

# Shaft Fixings

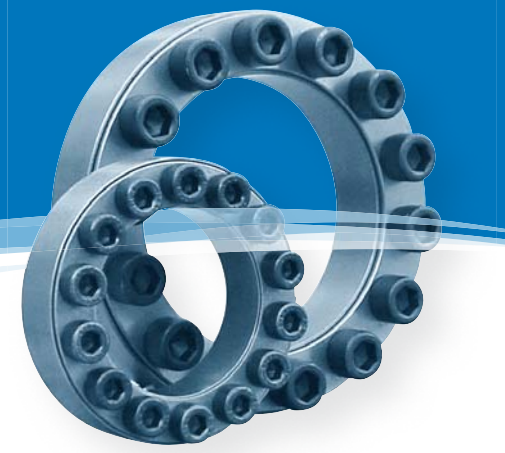

# Cone Clamping Elements

## SHAFTLOCK 01 Clamping Element

Dimensions					Transmission		Contact Pressure		Locking Screws (DIN 912-12.9)		
Ød mm	ØD mm	L <sub>1</sub> mm	L <sub>2</sub> mm	L mm	Torque	Axial	Shaft P N/mm <sup>2</sup>	Hub P <sub>1</sub> N/mm <sup>2</sup>	Qty.	Size	Tightening
					Mt Nm	Force Ft kN					Torque Ts Nm
19	47	17	20	26	299	26.8	220	93	8	M6x18	17
20	47	17	20	26	308	26.8	210	93	8	M6x18	17
22	47	17	20	26	325	26.8	207	96	8	M6x18	17
24	50	17	20	26	415	30.1	206	103	9	M6x18	17
25	50	17	20	26	432	30.1	206	103	9	M6x18	17
28	55	17	20	26	483	33.5	204	103	10	M6x18	17
30	55	17	20	26	518	33.5	190	103	10	M6x18	17
32	60	17	20	26	739	40.2	214	114	12	M6x18	17
35	60	17	20	26	808	40.2	196	114	12	M6x18	17
38	65	17	20	26	1025	46.9	204	122	14	M6x18	17
40	65	17	20	26	1079	46.9	200	122	14	M6x18	17
42	75	20	24	32	1768	73.2	228	125	12	M8x22	38
45	75	20	24	32	1894	73.2	208	125	12	M8x22	38
48	80	20	24	32	2019	73.2	190	110	12	M8x22	38
50	80	20	24	32	2105	73.2	189	115	12	M8x22	38
55	85	20	24	32	2700	85.4	200	130	14	M8x22	38
60	90	20	24	32	2944	85.4	180	122	14	M8x22	38
65	95	20	24	32	3646	97.6	191	130	16	M8x22	38
70	110	24	28	38	5405	134.4	211	132	14	M10x25	75
75	115	24	28	38	5750	134.4	194	128	14	M10x25	75
80	120	24	28	38	6095	134.4	182	124	14	M10x25	75
85	125	24	28	38	7475	153.6	196	133	16	M10x25	75
90	130	24	28	38	7935	153.6	181	128	16	M10x25	75
95	135	24	28	38	9430	172.8	196	139	18	M10x25	75
100	145	26	33	45	11351	197.4	198	139	14	M12x30	130
110	155	26	33	45	12420	187.4	181	128	14	M12x30	130
120	165	26	33	45	15525	225.6	187	139	16	M12x30	130
130	180	34	38	50	21045	282.0	168	119	20	M12x35	130
140	190	34	38	50	24955	310.1	168	128	22	M12x35	130
150	200	34	38	50	29095	338.4	170	128	24	M12x35	130
160	210	34	38	50	33695	366.6	171	132	26	M12x35	130
170	225	38	44	58	37950	389.0	162	123	22	M14x40	207
180	235	38	44	58	43700	424.0	168	128	24	M14x40	207
190	250	46	52	66	54050	495.0	154	114	28	M14x45	207
200	260	46	52	66	60950	531.0	157	118	30	M14x45	207
220	285	50	56	72	79810	631.0	152	117	26	M16X50	290

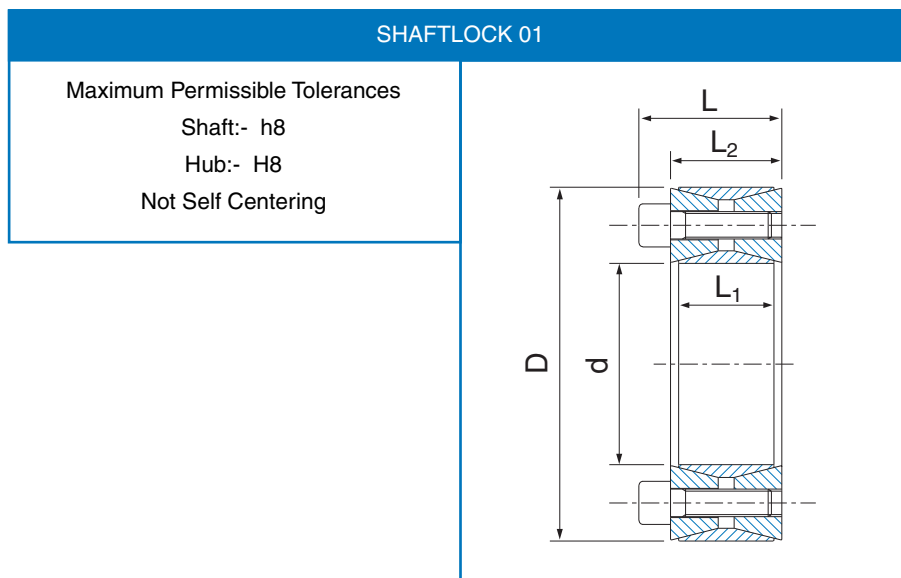

# Cone Clamping Elements

## SHAFTLOCK 02 Clamping Element

Dimensions								Transmission		Contact Pressure		Lock Screws (DIN912-129)		
Ød	ØD	L <sub>1</sub>	L <sub>2</sub>	L <sub>3</sub>	L	ØD <sub>2</sub>	ØD <sub>1</sub>	Torque Mt	Axial Force Ft	Shaft P	Hub P <sub>1</sub>	Qty.	Size	Tightening Torque Ts
mm	mm	mm	mm	mm	mm	mm	mm	Nm	kN	N/mm <sup>2</sup>	N/mm <sup>2</sup>			Nm
8	15	12	21	24	28	28	25	35	7.2	190.0	105.0	4	M4x10	5.2
9	16	14	23	27	31	32	28	37	7.2	150.0	92.0	4	M4x12	5.2
10	16	14	23	27	31	32	28	46	9.0	140.0	90.0	4	M4x12	5.2
11	18	14	23	27	31	34	30	58	9.0	174.8	106.8	4	M4x12	5.2
12	18	14	23	27	31	34	30	63	9.0	160.8	106.8	4	M4x12	5.2
14	23	14	23	27	31	39	35	74	9.0	137.4	83.6	4	M4x12	5.2
15	24	16	29	36	42	45	40	114	13.0	161.8	101.2	3	M6x18	17.0
16	24	16	29	36	42	45	40	121	13.0	151.7	101.2	3	M6x18	17.0
18	26	18	31	38	44	47	42	182	18.0	159.8	110.7	4	M6x18	17.0
19	27	18	31	38	44	48	43	192	18.0	151.4	106.6	4	M6x18	17.0
20	28	18	31	38	44	49	44	202	21.0	143.9	102.8	4	M6x18	17.0
22	32	25	38	45	51	54	48	267	21.0	112.8	77.6	4	M6x18	17.0
24	34	25	38	45	51	56	50	291	21.0	103.4	73.0	4	M6x18	17.0
25	34	25	38	45	51	56	50	302	21.0	99.3	73.0	4	M6x18	17.0
28	39	25	38	45	51	61	55	423	31.0	110.8	79.6	5	M6x18	17.0
30	41	25	38	45	51	63	57	545	31.0	124.1	90.8	6	M6x18	17.0
32	43	30	43	50	56	65	59	581	31.0	97.0	72.2	6	M6x18	17.0
35	47	30	43	50	56	69	63	848	42.0	118.9	88.0	8	M6x18	17.0
38	50	30	43	50	56	72	66	920	42.0	108.9	82.8	8	M6x18	17.0
40	53	32	45	52	58	75	69	1089	53.0	109.1	82.3	9	M6x18	17.0
42	55	32	45	52	58	77	71	1143	53.0	103.9	79.3	9	M6x18	17.0
45	59	40	56	64	72	85	79	2013	78.0	127.4	97.2	8	M8x22	42.0
48	62	40	56	64	72	88	82	2147	78.0	119.5	92.5	8	M8x22	42.0
50	65	50	66	74	82	92	85	2796	97.0	114.7	98.2	10	M8x22	42.0
55	71	50	66	74	82	98	91	3075	97.0	104.3	80.8	10	M8x22	42.0
60	77	50	66	74	82	104	97	3355	97.0	95.6	74.5	10	M8x22	42.0
65	84	50	66	74	82	111	104	3634	97.0	88.2	68.8	10	M8x22	42.0
70	90	60	80	91	101	122	115	4970	123.0	86.7	67.4	8	M10x25	84.0
75	95	60	80	91	101	126	119	6259	197.0	93.0	74.0	9	M10x25	84.0
80	100	65	85	96	106	131	124	8780	237.0	97.0	77.0	12	M10x25	84.0
85	106	65	85	96	106	137	130	9307	237.0	91.0	73.0	12	M10x25	84.0
90	112	65	85	96	106	143	136	11473	276.0	100.0	51.0	14	M10x25	84.0
95	120	65	85	96	106	153	144	12293	276.0	95.0	75.0	14	M10x25	84.0
100	125	65	89	102	114	162	153	15788	348.0	114.0	91.0	12	M12x30	145.0
110	140	70	94	107	119	177	168	17683	348.0	96.0	75.0	12	M12x30	145.0
120	155	90	114	127	139	195	185	26098	465.0	91.0	71.0	16	M12x30	145.0
130	165	90	114	127	139	205	195	27781	465.0	84.0	66.0	16	M12x30	145.0
140	175	90	114	127	139	215	205	29465	465.0	78.0	63.0	16	M12x30	145.0
150	185	90	114	127	139	225	215	31149	465.0	73.0	59.0	16	M12x30	145.0

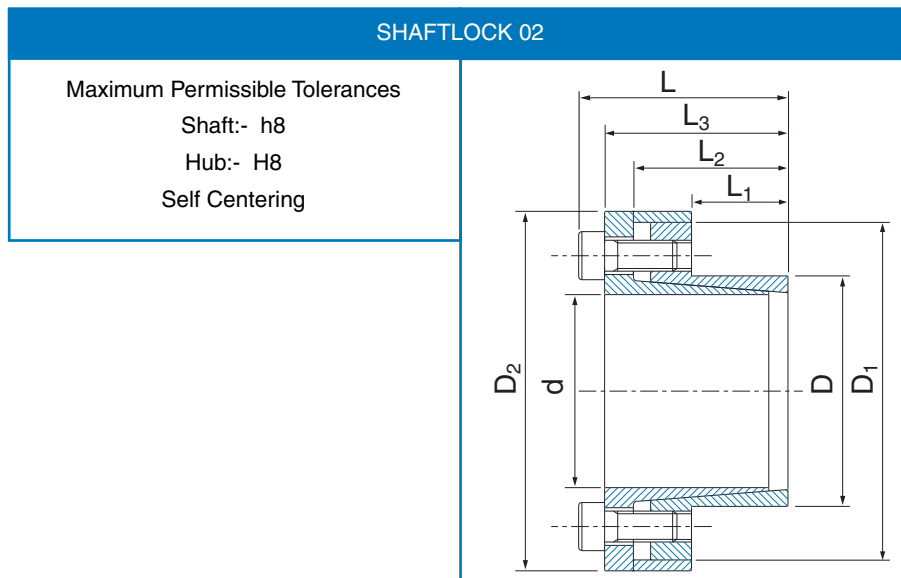

Every effort has been taken to ensure that the data listed in this catalogue is correct. Challenge accepts no liability for any inaccuracies or damage caused. All dimensions in millimetres unless otherwise stated.

# Cone Clamping Elements

## SHAFTLOCK 03 Clamping Element

Dimensions				Transmission Axial Force			Contact Pressure	
Ød mm	ØD mm	L mm	L <sub>1</sub> mm	Torque Mt Nm	Fa kN	Ft kN	Shaft P N/mm <sup>2</sup>	Hub P <sub>1</sub> N/mm <sup>2</sup>
8	11	4.5	3.7	0.97	4.3	2.9	98	73
10	13	4.5	3.7	1.37	12.1	6.9	98	75
12	15	4.5	3.7	1.64	12.4	9.8	98	78
13	16	4.5	3.7	1.80	12.7	12.0	98	79
14	18	6.3	5.3	2.74	20.4	19.2	98	76
15	19	6.3	5.3	2.94	23.5	22.1	98	77
16	20	6.3	5.3	3.14	23.9	25.1	98	78
17	21	6.3	5.3	3.33	24.2	28.3	98	79
18	22	6.3	5.3	3.53	24.8	31.8	98	80
19	24	6.3	5.3	3.72	29.1	35.3	98	77
20	25	6.3	5.3	3.92	29.5	39.2	98	78
22	26	6.3	5.3	4.31	28.3	47.0	98	83
24	28	6.3	5.3	4.70	29.4	56.8	98	84
25	30	6.3	5.3	4.90	31.8	60.8	98	81
28	32	6.3	5.3	5.49	31.9	76.4	98	86
30	35	6.3	5.3	5.88	34.8	88.2	98	84
32	36	6.3	5.3	6.27	35.9	100.0	98	87
35	40	7.0	6.0	7.74	44.8	136.0	98	86
36	42	7.0	6.0	7.94	47.3	144.0	98	84
38	44	7.0	6.0	8.43	48.8	160.0	98	84
40	45	8.0	6.6	9.75	57.6	195.0	98	87
42	48	8.0	6.6	10.30	61.4	216.0	98	86
45	52	10.0	8.6	14.30	90.3	321.0	98	85
48	55	10.0	8.6	15.30	92.7	367.0	98	85
50	57	10.0	8.6	15.90	94.7	397.0	98	86
55	62	10.0	8.6	17.40	99.7	480.0	98	87
56	64	12.0	10.4	21.60	125.6	603.0	98	86
60	68	12.0	10.4	23.00	130.9	692.0	98	86
63	71	12.0	10.4	24.20	134.6	764.0	98	87
65	73	12.0	10.4	25.00	134.9	813.0	98	87
70	79	14.0	12.2	31.60	172.4	1110.0	98	87
71	80	14.0	12.2	32.00	174.0	1140.0	98	87
75	84	14.0	12.2	33.80	185.7	1260.0	98	87
80	91	17.0	15.0	44.10	247.1	1770.0	98	86
90	101	17.0	15.0	50.00	266.2	2240.0	98	87
100	114	21.0	18.7	69.60	370.8	3450.0	98	86
110	124	21.0	18.7	76.40	406.1	4170.0	98	87
120	134	21.0	18.7	83.30	432.0	4950.0	98	88
130	148	28.0	25.3	122.00	640.8	7840.0	98	86
140	158	28.0	25.3	131.00	676.5	9110.0	98	87
150	168	28.0	25.3	140.00	713.0	10500.0	98	87

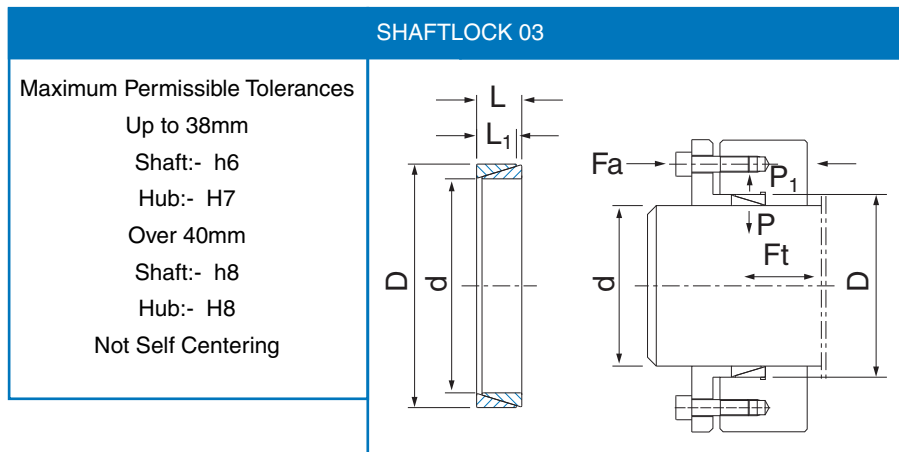

# Cone Clamping Elements

## SHAFTLOCK 04 Clamping Element

Dimensions						Transmission Axial Force		Contact Pressure		Lock Screws (DIN 912-12.9)		
Ød mm	ØD mm	L <sub>1</sub> mm	L <sub>2</sub> mm	L <sub>3</sub> mm	L mm	Torque Mt Nm	Force Ft kN	Shaft P N/mm <sup>2</sup>	Hub P <sub>1</sub> N/mm <sup>2</sup>	Qty.	Size	Tightening Torque Ts Nm
19	47	26	31	39	45	332	32	193	78	4	M6x25	17
20	47	26	31	39	45	349	32	183	78	4	M6x25	17
22	47	26	31	39	45	383	32	166	78	4	M6x25	17
24	50	26	31	39	45	629	48	229	110	6	M6x25	17
25	50	26	31	39	45	654	48	220	110	6	M6x25	17
28	55	26	31	39	45	733	48	196	100	6	M6x25	17
30	55	26	31	39	45	785	48	183	100	6	M6x25	17
32	60	26	31	39	45	1116	65	229	122	8	M6x25	17
35	60	26	31	39	45	1220	65	209	122	8	M6x25	17
38	65	26	31	39	45	1325	65	193	113	8	M6x25	17
40	65	26	31	39	45	1395	65	183	113	8	M6x25	17
42	75	30	36	47	55	1982	87	204	115	6	M8x30	41
45	75	30	36	47	55	2123	87	191	115	6	M8x30	41
48	80	30	36	47	55	2265	87	179	107	6	M8x30	41
50	80	30	36	47	55	2359	87	172	107	6	M8x30	41
55	85	30	36	47	55	3458	116	208	135	8	M8x30	41
60	90	30	36	47	55	3772	116	191	127	8	M8x30	41
65	95	30	36	47	55	4087	116	176	120	8	M8x30	41
70	110	40	46	57	67	7136	189	199	127	8	M10x35	83
75	115	40	46	62	72	7645	189	186	121	8	M10x35	83
80	120	40	46	62	72	8155	189	174	116	8	M10x35	83
85	125	40	46	62	72	10831	236	205	139	10	M10x35	83
90	130	40	46	62	72	11469	236	193	134	10	M10x35	83
95	135	40	46	62	72	12106	236	183	129	10	M10x35	83
100	145	46	52	77	89	14837	275	176	121	8	M12x45	145
110	155	46	52	77	89	16320	275	160	114	8	M12x45	145
120	165	46	52	77	89	22254	343	183	133	10	M12x45	145
130	180	46	52	77	89	28931	412	203	147	12	M12x45	145
140	190	51	59	84	98	28233	373	154	114	8	M14x45	230
150	200	51	59	84	98	37817	467	180	135	10	M14x45	230
160	210	51	59	84	98	40339	467	169	129	10	M14x45	230
170	225	51	59	84	98	51426	560	191	144	12	M14x45	230
180	235	51	59	84	98	54451	560	180	138	12	M14x45	230

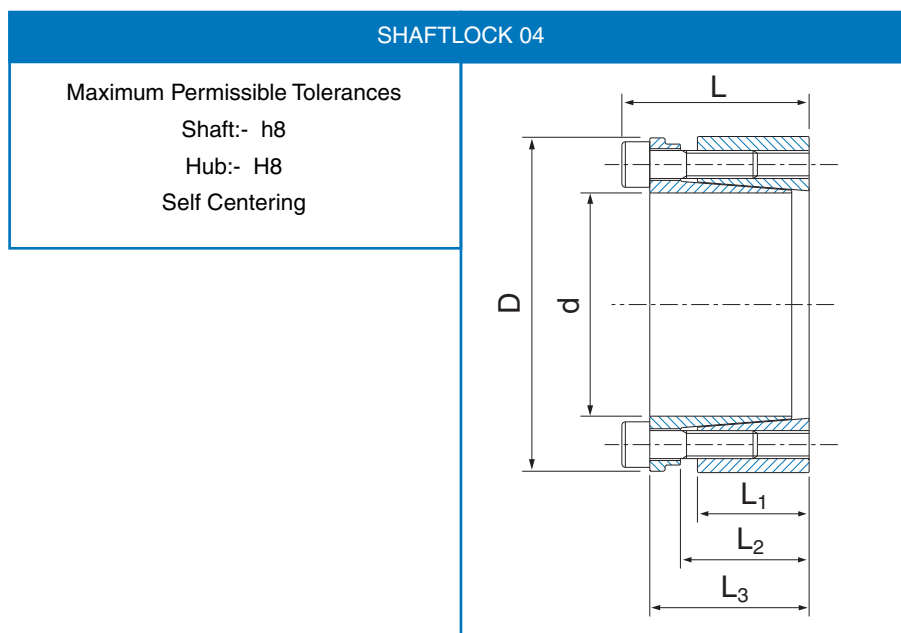

# Cone Clamping Elements

## SHAFTLOCK 05 Clamping Element

Dimensions						Transmission Axial Force		Contact Pressure		Lock Screws (DIN 912-12.9) Tightening		
Ød mm	ØD mm	L <sub>1</sub> mm	L <sub>2</sub> mm	L <sub>3</sub> mm	L mm	Mt Nm	Ft kN	Shaft P N/mm <sup>2</sup>	Hub P <sub>1</sub> N/mm <sup>2</sup>	Qty.	Size	Ts Nm
19	47	17	22	28	34	295	29	262	106	5	M6x20	13
20	47	17	22	28	34	310	29	249	106	5	M6x20	13
22	47	17	22	28	34	341	29	227	106	5	M6x20	13
24	50	17	22	28	34	446	34	249	120	6	M6x20	13
25	50	17	22	28	34	465	34	239	120	6	M6x20	13
28	55	17	22	28	34	521	34	213	109	6	M6x20	13
30	55	17	22	28	34	558	34	199	109	6	M6x20	13
32	60	17	22	28	34	793	46	249	133	8	M6x20	13
35	60	17	22	28	34	867	46	227	133	8	M6x20	13
38	65	17	22	28	34	942	46	210	122	8	M6x20	13
40	65	17	22	28	34	991	46	199	122	8	M6x20	13
42	75	20	25	33	41	1688	74	261	146	7	M8x25	32
45	75	20	25	33	41	1808	74	244	146	7	M8x25	32
50	80	20	25	33	41	2009	74	219	137	7	M8x25	32
55	85	20	25	33	41	2527	85	228	148	8	M8x25	32
60	90	20	25	33	41	2757	85	209	139	8	M8x25	32
65	95	20	25	33	41	3359	96	217	149	9	M8x25	32
70	110	24	30	40	50	5225	138	243	154	8	M10x30	65
75	115	24	30	40	50	5599	138	226	148	8	M10x30	65
80	120	24	30	40	50	5972	138	212	142	8	M10x30	65
85	125	24	30	40	50	7139	156	225	153	9	M10x30	65
90	130	24	30	40	50	7558	156	212	147	9	M10x30	65
95	135	24	30	40	50	8865	173	223	157	10	M10x30	65
100	145	26	32	44	56	10521	195	221	152	8	M12x35	110
110	155	26	32	44	56	11573	195	201	143	8	M12x35	110
120	165	26	32	44	56	14206	219	207	151	9	M12x35	110
130	180	34	40	52	64	20516	292	195	141	12	M12x35	110
140	190	34	40	54	68	21963	291	180	133	9	M14x40	170
150	200	34	40	54	68	26148	323	187	140	10	M14x40	170
160	210	34	40	54	68	30681	355	192	147	11	M14x40	170
170	225	44	50	64	78	35563	387	153	115	12	M14x40	170
180	235	44	50	64	78	37655	387	144	110	12	M14x40	170

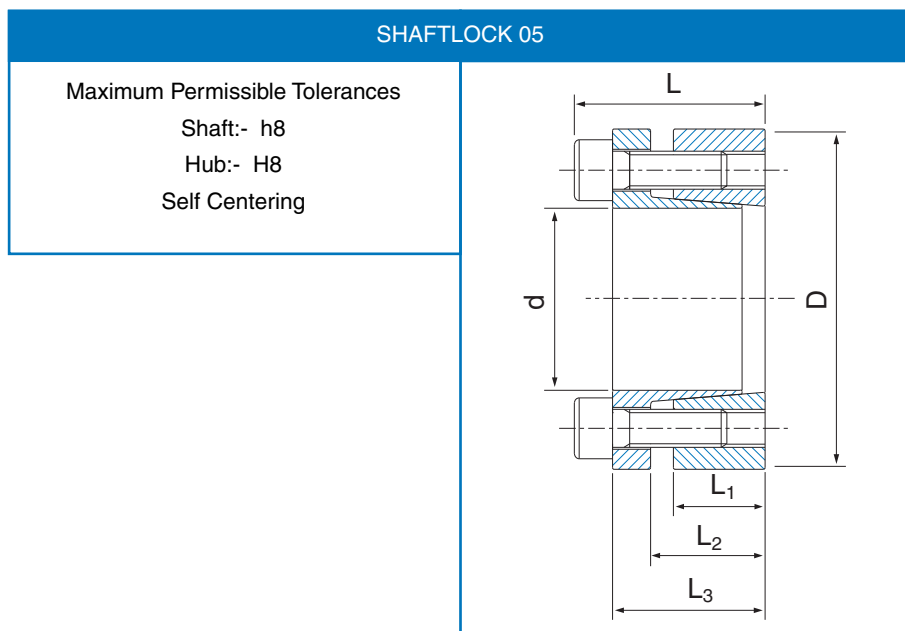

All dimensions in millimetres unless otherwise stated. Every effort has been taken to ensure that the data listed in this catalogue is correct. Challenge accepts no liability for any inaccuracies or damage caused.

# Cone Clamping Elements

## SHAFTLOCK 06 Clamping Element

Dimensions							Transmission Axial		Contact Pressure		Lock Screws (DIN 912-12.9)		
Ød	ØD	ØD <sub>1</sub>	L <sub>1</sub>	L <sub>2</sub>	L <sub>3</sub>	L	Torque Mt	Force Ft	Shaft P	Hub P <sub>1</sub>	Qty.	Size	Tightening Torque Ts
mm	mm	mm	mm	mm	mm	mm	Nm	kN	N/mm <sup>2</sup>	N/mm <sup>2</sup>			Nm
19	47	53	26	31	39	45	203	20	118	48	4	M6x20	17
20	47	53	26	31	39	45	214	20	112	48	4	M6x20	17
22	47	53	26	31	39	45	234	20	102	48	4	M6x20	17
24	50	56	26	31	39	45	384	30	140	67	6	M6x20	17
25	50	56	26	31	39	45	401	30	135	67	6	M6x20	17
28	55	61	26	31	39	45	449	30	120	61	6	M6x20	17
30	55	61	26	31	39	45	482	30	112	61	6	M6x20	17
32	60	66	26	31	39	45	685	40	140	75	8	M6x20	17
35	60	66	26	31	39	45	750	40	128	75	8	M6x20	17
38	65	71	26	31	39	45	813	40	118	69	8	M6x20	17
40	65	71	26	31	39	45	856	40	112	69	8	M6x20	17
42	75	81	30	36	47	55	1215	54	125	70	6	M8x30	41
45	75	81	30	36	47	55	1301	54	117	70	6	M8x30	41
48	80	86	30	36	47	55	1389	54	110	66	6	M8x30	41
50	80	86	30	36	47	55	1446	54	105	66	6	M8x30	41
55	85	91	30	36	47	55	2120	71	128	83	8	M8x30	41
60	90	96	30	36	47	55	2313	71	117	78	8	M8x30	41
65	95	101	30	36	47	55	2506	71	108	74	8	M8x30	41
70	110	116	40	46	57	67	4372	116	122	78	8	M10x35	83
75	115	121	40	46	62	72	4685	116	114	74	8	M10x35	83
80	120	126	40	46	62	72	4997	116	107	71	8	M10x35	83
85	125	131	40	46	62	72	6638	145	125	85	10	M10x35	83
90	130	136	40	46	62	72	7029	145	118	82	10	M10x35	83
95	135	141	40	46	62	72	7419	145	112	79	10	M10x35	83
100	145	151	46	52	77	89	9093	168	108	74	8	M12x45	145
110	155	161	46	52	77	89	10001	168	98	70	8	M12x45	145
120	165	171	46	52	77	89	13640	210	112	82	10	M12x45	145
130	180	186	46	52	77	89	17734	253	125	90	12	M12x45	145
140	190	196	51	59	84	98	17302	229	95	70	8	M14x45	230
150	200	206	51	59	84	98	23174	286	110	83	10	M14x45	230
160	210	216	51	59	84	98	24718	286	103	79	10	M14x45	230
170	225	231	51	59	84	98	31518	343	117	88	12	M14x45	230
180	235	241	51	59	84	98	33372	343	110	84	12	M14x45	230

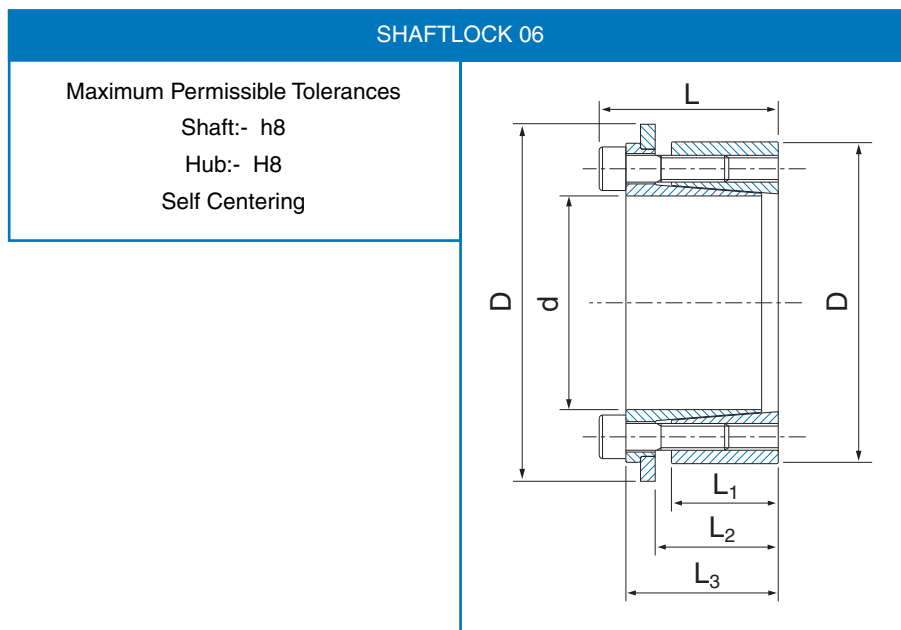

# Cone Clamping Elements

## SHAFTLOCK 07 Clamping Element

Dimensions							Transmission Axial		Contact Pressure		Lock Screws (DIN 912-12.9)		
Ød	ØD	ØD <sub>1</sub>	L <sub>1</sub>	L <sub>2</sub>	L <sub>3</sub>	L	Torque Mt	Force Ft	Shaft P	Hub P <sub>1</sub>	Qty.	Size	Tightening Torque Ts
mm	mm	mm	mm	mm	mm	mm	Nm	kN	N/mm <sup>2</sup>	N/mm <sup>2</sup>			Nm
19	47	56	17	22	28	34	244	24	217	88	5	M6x20	17
20	47	56	17	22	28	34	257	24	206	88	5	M6x20	17
22	47	56	17	22	28	34	282	24	187	88	5	M6x20	17
24	50	59	17	22	28	34	369	29	206	99	6	M6x20	17
25	50	59	17	22	28	34	384	29	198	99	6	M6x20	17
28	55	64	17	22	28	34	431	29	177	90	6	M6x20	17
30	55	64	17	22	28	34	462	29	165	90	6	M6x20	17
32	60	69	17	22	28	34	657	38	206	110	8	M6x20	17
35	60	69	17	22	28	34	718	38	188	110	8	M6x20	17
38	65	74	17	22	28	34	780	38	174	101	8	M6x20	17
40	65	74	17	22	28	34	821	38	165	101	8	M6x20	17
42	75	84	20	25	33	41	1360	60	210	118	7	M8x25	41
45	75	84	20	25	33	41	1457	60	196	118	7	M8x25	41
50	80	89	20	25	33	41	1619	60	177	110	7	M8x25	41
55	85	94	20	25	33	41	2034	68	184	119	8	M8x25	41
60	90	99	20	25	33	41	2218	68	168	112	8	M8x25	41
65	95	104	20	25	33	41	2703	77	175	120	9	M8x25	41
70	110	119	24	30	40	50	4197	111	195	124	8	M10x30	83
75	115	124	24	30	40	50	4496	111	182	119	8	M10x30	83
80	120	129	24	30	40	50	4796	111	171	114	8	M10x30	83
85	125	134	24	30	40	50	5730	125	180	123	9	M10x30	83
90	130	139	24	30	40	50	6067	125	170	118	9	M10x30	83
95	135	144	24	30	40	50	7114	139	179	126	10	M10x30	83
100	145	154	26	32	44	56	8724	162	183	126	8	M12x35	145
110	155	164	26	32	44	56	9597	162	167	118	8	M12x35	145
120	165	174	26	32	44	56	11771	182	172	125	9	M12x35	145
130	180	189	34	40	52	64	17006	242	162	117	12	M12x35	145
140	190	199	34	40	54	68	18673	247	153	113	9	M14x40	230
150	200	209	34	40	54	68	22229	274	159	119	10	M14x40	230
160	210	219	34	40	54	68	26081	302	164	125	11	M14x40	230
170	225	234	44	50	64	78	30229	329	130	98	12	M14x40	230
180	235	244	44	50	64	78	32007	329	123	94	12	M14x40	230

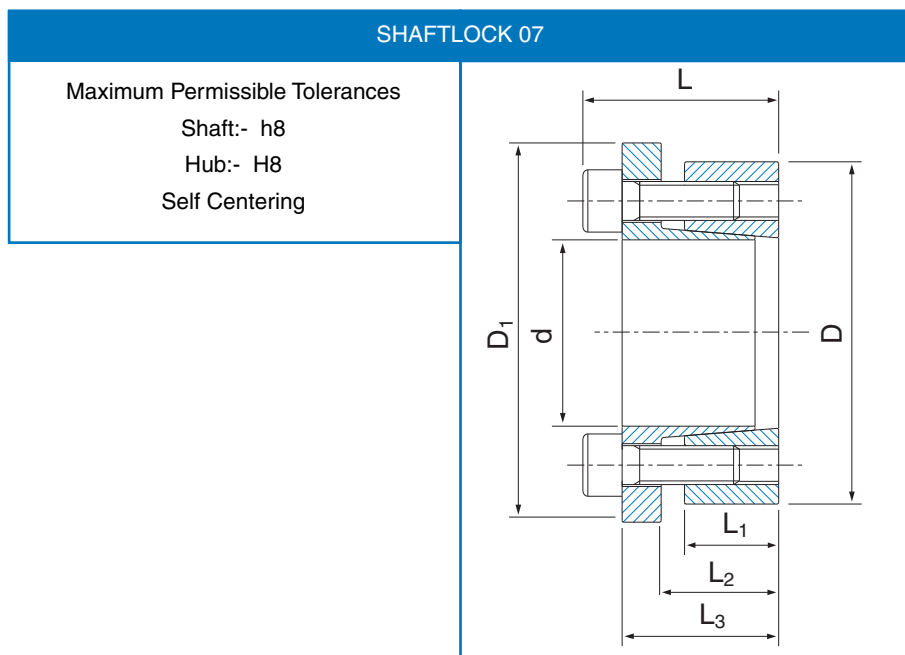

All dimensions in millimetres unless otherwise stated. Every effort has been taken to ensure that the data listed in this catalogue is correct. Challenge accepts no liability for any inaccuracies or damage caused.



# Cone Clamping Elements

## SHAFTLOCK 14 Clamping Element

Dimensions							Transmission Torque Mt Nm	Axial Force Ft kN	Contact Press Shaft P N/mm <sup>2</sup>	Lock Screws (DIN 912-12.9) Tightening		
Ød mm	ØD mm	dw mm	L <sub>1</sub> mm	L <sub>2</sub> mm	L mm	C <sub>(dw-d1)</sub> mm				Qty.	Size	Torque Ts Nm
24	50	19	14	19.5	23.0	0.017	162	15.0	272	6	M5x18	4.9
		20					200	18.5				
		21					238	21.0				
30	60	24	16	21.5	25.0	0.017	285	15.7	221	7	M5x18	4.9
		25					323	23.7				
		26					361	26.7				
36	72	28	18	23.5	27.5	0.032	418	27.0	292	5	M6x20	11.8
		30					542	38.0				
		31					599	43.0				
44	80	32	20	25.5	29.5	0.032	589	44.0	301	7	M6x20	11.8
		35					741	49.0				
		36					817	54.0				
50	90	38	22	27.5	31.5	0.032	893	48.8	275	8	M6x25	11.8
		40					1102	58.8				
		42					1311	69.0				
55	100	42	23	30.5	34.5	0.032	1102	48.0	239	8	M6x25	11.8
		45					1444	61.7				
		48					1786	77.0				
62	110	48	23	30.5	34.5	0.048	1758	69.0	265	10	M6x25	11.8
		50					2090	80.9				
		52					2280	90.0				
68	115	50	23	30.5	34.5	0.048	1900	71.2	242	10	M6x25	11.8
		55					2375	80.9				
		60					2993	95.7				
75	138	55	25	32.5	37.8	0.048	2375	94.4	259	7	M8x30	29.4
		60					3040	111.0				
		65					3753	126.0				
80	145	60	25	32.5	37.8	0.048	3040	99.3	243	7	M8x30	29.4
		65					3705	115.0				
		70					4370	130.0				
90	155	65	30	39.0	44.3	0.048	4513	141.0	257	10	M8x35	29.4
		70					5700	160.0				
		75					6888	178.0				
100	170	70	34	44.0	49.3	0.048	6555	163.0	245	12	M8x35	29.4
		75					7125	182.0				
		80					8550	202.0				
110	185	75	39	50.0	56.4	0.048	6840	185.0	232	9	M10x40	57.8
		80					8550	207.0				
		85					10260	221.0				
125	215	85	42	54.0	60.4	0.069	10450	240.0	253	12	M10x40	57.8
		90					12350	262.0				
		95					14250	285.0				

# Cone Clamping Elements

## SHAFTLOCK 14 Clamping Element

Dimensions							Transmission Torque Mt Nm	Axial Force Ft kN	Contact Press Shaft P N/mm <sup>2</sup>	Lock Screws (DIN 912-12.9) Tightening		
Ød mm	ØD mm	d <sub>w</sub> mm	L <sub>1</sub> mm	L <sub>2</sub> mm	L mm	C <sub>(d<sub>w</sub>-d1)</sub> mm				Qty.	Size	Torque Ts Nm
140	230	95	46	60.5	68.0	0.069	14345	308.0	251	10	M12x45	98.0
		100					16720	331.0				
		105					19095	357.0				
155	265	105	50	64.5	72.0	0.069	20900	366.0	250	12	M12x50	98.0
		110					23750	392.0				
		115					26600	417.0				
165	290	115	56	71.0	81.0	0.069	29450	513.0	263	8	M16x55	245.0
		120					33250	544.0				
		125					37050	564.0				
175	300	125	56	71.0	81.0	0.079	34200	576.0	248	8	M16x55	250.0
		130					38950	630.0				
		135					45000	666.0				

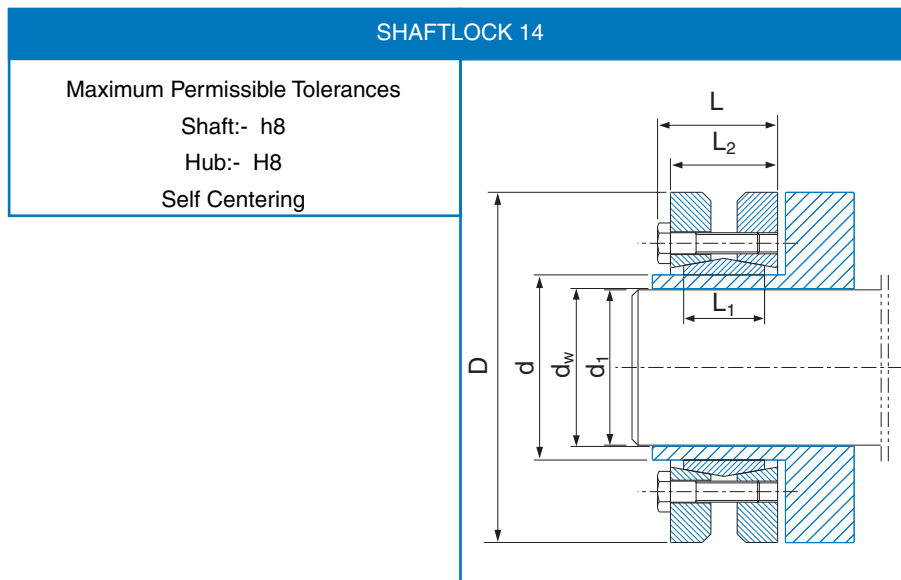

# Cone Clamping Elements

## SHAFTLOCK 15 Clamping Element

Dimensions							Transmission Axial		Contact Pressure		Lock Screws (DIN 912-12.9)		
Ød	ØD	ØD <sub>1</sub>	L <sub>1</sub>	L <sub>2</sub>	L <sub>3</sub>	L	Torque Mt	Force Ft	Shaft P	Hub P <sub>1</sub>	Qty.	Size	Tightening Torque Ts
mm	mm	mm	mm	mm	mm	mm	Nm	kN	N/mm <sup>2</sup>	N/mm <sup>2</sup>			Nm
14	55	62	17	22	31	39	233	31	383	97	4	M8x25	37
16	55	62	17	22	31	39	267	31	335	97	4	M8x25	37
18	55	62	17	22	31	39	333	34	330	108	4	M8x25	41
19	55	62	17	22	31	39	351	34	313	108	4	M8x25	41
20	55	62	17	22	31	39	369	34	297	108	4	M8x25	41
22	55	62	17	22	31	39	407	34	270	108	4	M8x25	41
24	55	62	17	22	31	39	444	34	247	108	4	M8x25	41
25	55	62	17	22	31	39	462	34	238	108	4	M8x25	41
28	55	62	17	22	31	39	517	34	212	108	4	M8x25	41
30	55	62	17	22	31	39	555	34	198	108	4	M8x25	41
24	65	72	17	22	31	39	554	43	309	114	5	M8x25	41
25	65	72	17	22	31	39	578	43	297	114	5	M8x25	41
28	65	72	17	22	31	39	647	43	265	114	5	M8x25	41
30	65	72	17	22	31	39	693	43	247	114	5	M8x25	41
32	65	72	17	22	31	39	739	43	232	114	5	M8x25	41
35	65	72	17	22	31	39	808	43	212	114	5	M8x25	41
38	65	72	17	22	31	39	878	43	195	114	5	M8x25	41
40	65	72	17	22	31	39	923	43	185	114	5	M8x25	41
30	80	87	20	25	33	41	971	60	295	110	7	M8x25	41
32	80	87	20	25	33	41	1036	60	276	110	7	M8x25	41
35	80	87	20	25	33	41	1133	60	253	110	7	M8x25	41
38	80	87	20	25	33	41	1230	60	233	110	7	M8x25	41
40	80	87	20	25	33	41	1295	60	221	110	7	M8x25	41
42	80	87	20	25	33	41	1360	60	210	110	7	M8x25	41
45	80	87	20	25	33	41	1457	60	196	110	7	M8x25	41
48	80	87	20	25	33	41	1554	60	184	110	7	M8x25	41
50	80	87	20	25	33	41	1619	60	177	110	7	M8x25	41

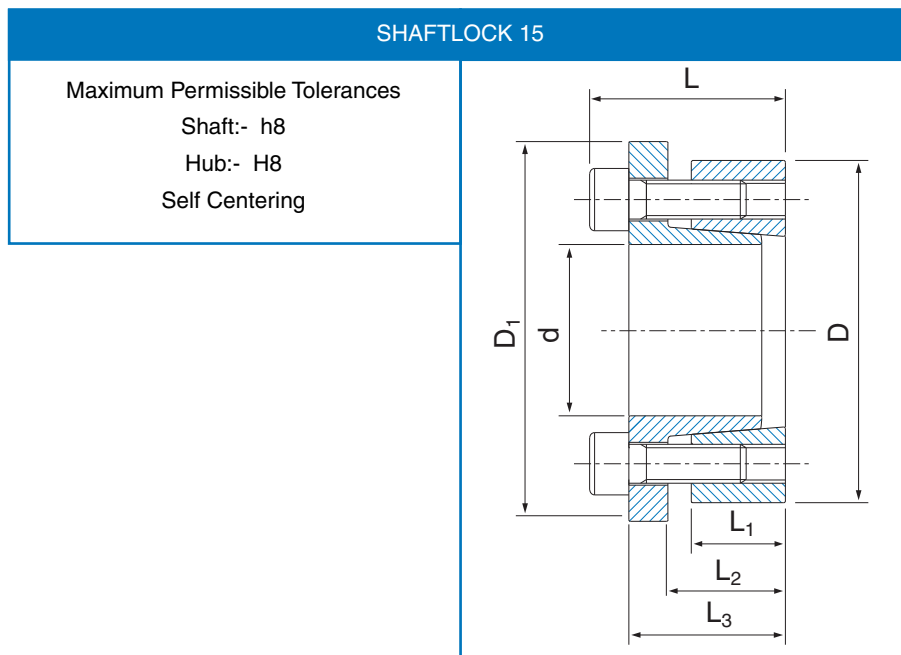

# Cone Clamping Elements

## SHAFTLOCK 16 Clamping Element

Dimensions				Transmission		Contact Pressure		Lock Screws (DIN 912-12.9)		
$\varnothing d$ mm	$\varnothing D$ mm	L mm	$L_1$ mm	Torque Mt Nm	Axial Force Ft kN	Shaft P N/mm <sup>2</sup>	Hub P <sub>1</sub> N/mm <sup>2</sup>	Qty.	Size	Tightening Torque Ts Nm
16	32	24	18.0	79	9	83	41	4	M4x16	5
16	40	24	18.0	231	23	83	74	4	M6x16	17
19	41	24	18.0	244	23	155	72	4	M6x16	17
20	42	24	18.0	256	23	147	70	4	M6x16	17
22	44	24	18.0	283	23	134	67	4	M6x16	17
24	46	24	18.0	462	35	184	96	6	M6x16	17
25	47	24	18.0	482	35	177	94	6	M6x16	17
28	50	24	18.0	539	35	158	88	6	M6x16	17
30	52	24	18.0	578	35	147	85	6	M6x16	17
32	54	24	18.0	616	35	138	82	6	M6x16	17
35	57	28	21.5	671	26	135	80	6	M6x18	17
36	58	28	21.5	693	35	103	64	8	M6x18	17
38	60	28	21.5	732	35	97	62	8	M6x18	17
40	62	28	21.5	770	35	93	60	8	M6x18	17
42	70	36	28.0	1903	82	159	96	8	M8x25	40
45	73	36	28.0	2038	82	149	92	8	M8x25	40
48	76	36	28.0	2175	82	139	88	8	M8x25	40
50	78	36	28.0	2265	82	134	86	8	M8x25	40
55	83	36	28.0	2848	94	139	92	8	M8x25	40
60	88	36	28.0	3106	94	127	87	8	M8x25	40
65	93	45	35.0	3366	94	94	66	8	M8x25	40
70	105	45	35.0	5138	133	124	83	8	M10x30	81
75	110	45	35.0	5504	133	116	79	8	M10x30	81
80	115	45	35.0	6606	150	122	85	8	M10x30	81
85	120	45	35.0	7798	167	127	90	10	M10x30	81
90	125	45	35.0	8257	167	120	87	10	M10x30	81
100	138	45	35.0	9174	167	108	79	10	M10x30	81

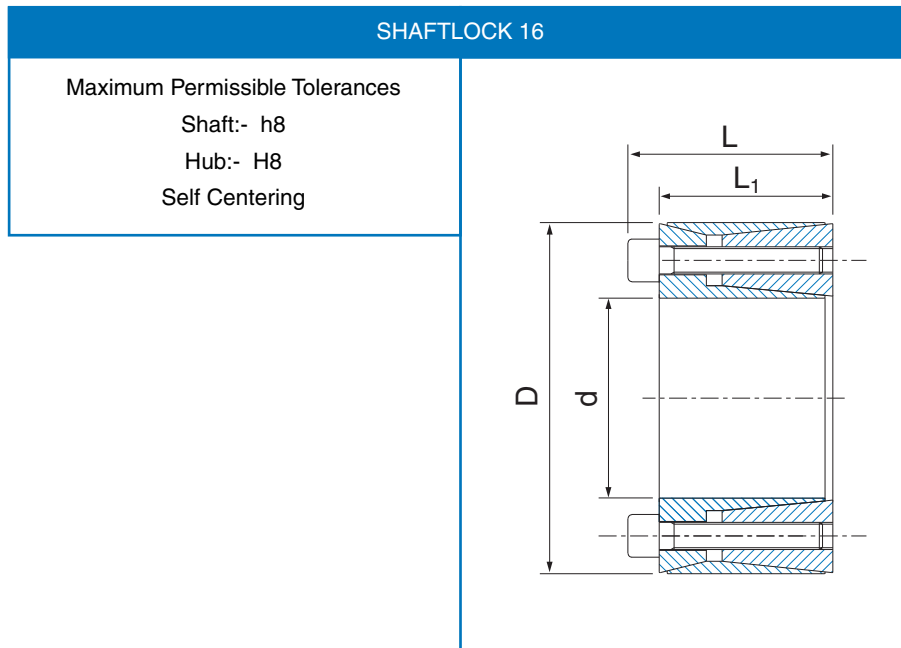

# Cone Clamping Elements

## SHAFTLOCK 19 Clamping Element

Dimensions					Transmission		Contact Pressure		Locking Screws (DIN 912-12.9)		
Ød	ØD	L	L <sub>2</sub>	L <sub>1</sub>	Torque	Axial Force	Shaft	Hub	Qty.	Size	Tightening Torque
mm	mm	mm	mm	mm	Mt Nm	Ft kN	P N/mm <sup>2</sup>	P <sub>1</sub> N/mm <sup>2</sup>			T <sub>s</sub> Nm
25	55	46	40	32	802	59	292	100	6	M6X35	17
28	55	46	40	32	899	59	261	100	6	M6X35	17
30	55	46	40	32	962	59	243	100	6	M6X35	17
35	60	60	54	44	1308	69	172	77	7	M6X45	17
38	75	62	54	44	2562	125	285	112	7	M8X50	41
40	75	62	54	44	2697	125	271	112	7	M8X50	41
42	75	62	54	44	2832	125	258	112	7	M8X50	41
45	75	62	54	44	3034	125	241	112	7	M8X50	41
48	80	72	64	56	3701	143	199	94	8	M8X55	41
50	80	72	64	56	3855	143	191	94	8	M8X55	41
55	85	72	64	56	4769	161	196	99	9	M8X55	41
60	90	72	64	56	5780	178	199	104	10	M8X55	41
65	95	72	64	56	6263	178	184	99	10	M8X55	41
70	110	88	78	70	10933	289	218	111	10	M10X60	83
75	115	88	78	70	11714	289	203	106	10	M10X60	83
80	120	88	78	70	13745	318	209	112	11	M10X60	83
85	125	88	78	70	15932	347	215	117	12	M10X60	83
90	130	88	78	70	16870	347	203	112	12	M10X60	83
95	135	88	78	70	17807	347	192	108	12	M10X60	83
100	145	112	100	90	25002	463	195	105	11	M12X80	145
110	155	112	100	90	30003	505	193	107	12	M12X80	145
120	165	112	100	90	38190	589	207	117	14	M12X80	145
130	180	130	116	104	48204	687	185	108	12	M14X90	230
140	190	130	116	104	60559	801	201	120	14	M14X90	230
150	200	130	116	104	69521	858	201	122	15	M14X90	230
160	210	130	116	104	79100	916	201	124	16	M14X90	230
170	225	164	148	134	100770	1098	190	107	14	M16X110	360
180	235	164	148	134	114319	1176	193	110	15	M16X110	360
190	250	164	148	134	128714	1255	195	110	16	M16X110	360
200	260	164	148	134	135489	1255	185	106	16	M16X110	360
220	285	164	148	134	167668	1411	189	109	18	M16X110	360

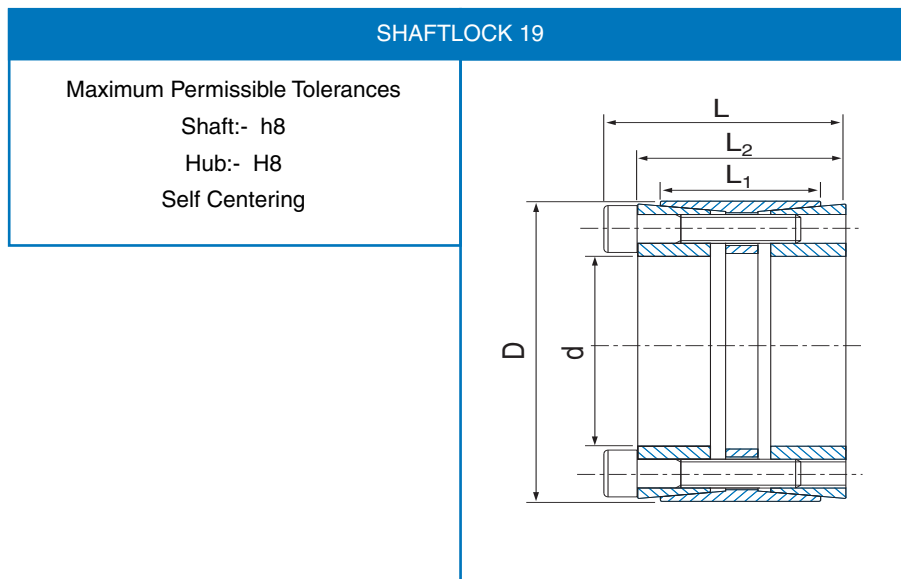

# Cone Clamping Elements

## SHAFTLOCK 20 Clamping Element

Dimensions					Transmission		Contact Pressure		Locking Screws (DIN 912-12.9)		
Ød	ØD	L	L <sub>1</sub>	L <sub>2</sub>	Torque	Axial Force	Shaft	Hub	Qty.	Size	Tightening Torque
mm	mm	mm	mm	mm	Mt Nm	Ft kN	P N/mm <sup>2</sup>	P <sub>1</sub> N/mm <sup>2</sup>			T <sub>s</sub> Nm
18	40	24.5	18.5	12	184	19	167	75	6	M6X15	17
19	41	24.5	18.5	12	194	19	159	73	6	M6X15	17
20	42	24.5	18.5	12	204	19	151	72	6	M6X15	17
24	46	24.5	18.5	12	245	19	126	65	6	M6X15	17
25	47	24.5	18.5	12	341	25	161	86	8	M6X15	17
28	50	24.5	18.5	12	382	25	144	81	8	M6X15	17
30	52	24.5	18.5	12	409	25	134	77	8	M6X15	17
35	57	28.0	22.0	15	716	38	145	89	12	M6X15	17
38	60	28.0	22.0	15	778	38	134	85	12	M6X15	17
40	62	28.0	22.0	15	819	38	127	82	12	M6X15	17
42	70	36.0	28.0	18	1551	68	171	103	12	M8X22	41
45	73	36.0	28.0	18	1661	68	160	99	12	M8X22	41
48	76	36.0	28.0	18	1772	68	150	95	12	M8X22	41
50	78	36.0	28.0	18	1846	68	144	92	12	M8X22	41
55	83	36.0	28.0	18	2708	91	175	116	16	M8X22	41
60	88	36.0	28.0	18	2954	91	160	109	16	M8X22	41
70	105	45.0	35.0	22	4037	107	129	86	12	M10X25	80
80	115	45.0	35.0	22	6150	142	150	104	16	M10X25	80

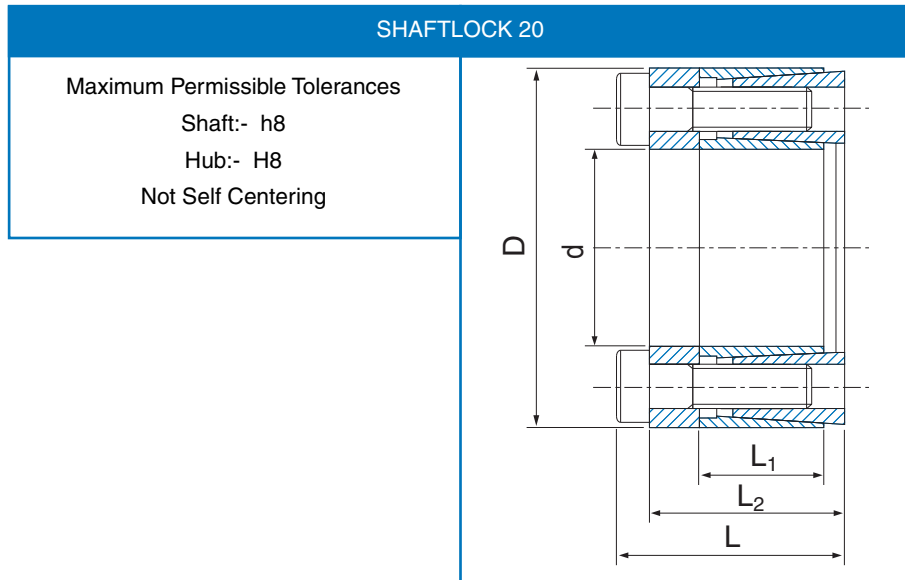

# Cone Clamping Elements

## SHAFTLOCK 21 Clamping Element

Dimensions					Transmission		Contact Pressure		Locking Screws (DIN 912-12.9)		
Ød	ØD	ØD <sub>1</sub>	L	L <sub>1</sub>	Torque	Axial Force	Shaft	Hub	Qty.	Size	Tightening Torque
mm	mm	mm	mm	mm	Mt Nm	Ft kN	P N/mm <sup>2</sup>	P <sub>1</sub> N/mm <sup>2</sup>			T <sub>s</sub> Nm
15	25	32	31	20	83	9	91	55	1	M20x1.0	95
18	30	38	33	21	135	13	98	59	1	M25x1.5	160
19	30	38	33	21	143	13	93	59	1	M25x1.5	160
20	30	38	33	21	150	13	88	59	1	M25x1.5	160
24	35	45	38	25	218	15	74	51	1	M30x1.5	220
25	35	45	38	25	227	15	71	51	1	M30x1.5	220
28	40	52	44	28	337	20	76	53	1	M35x1.5	340
30	40	52	44	28	362	20	71	53	1	M35x1.5	340
35	45	58	45	28	522	25	75	58	1	M40x1.5	480
40	50	65	46	28	752	31	82	66	1	M45x1.5	680
45	55	70	47	28	974	36	84	69	1	M50x1.5	870
50	60	75	47	28	1095	37	77	64	1	M55x2.0	970
55	65	80	48	28	1251	38	73	61	1	M60x2.0	1100
60	70	85	50	28	1489	41	73	62	1	M65x2.0	1300

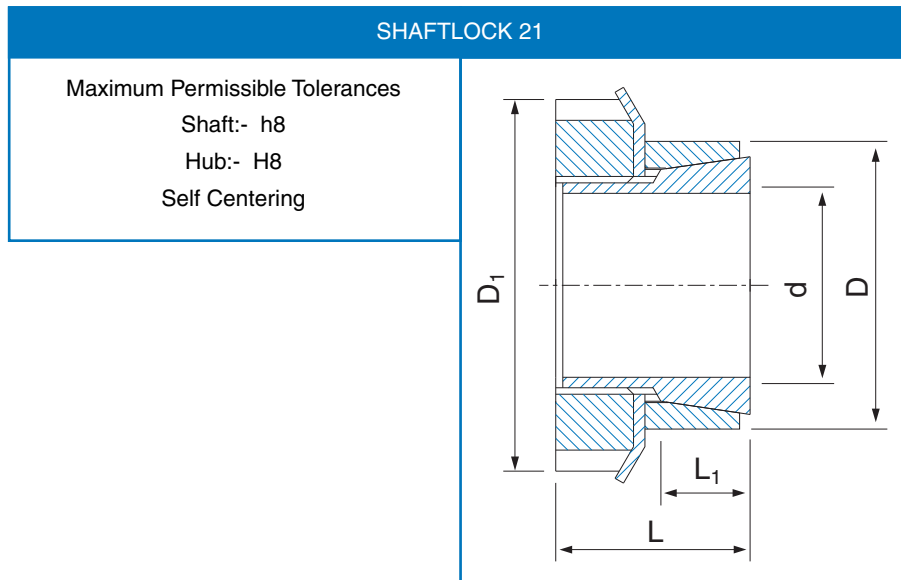

# Cone Clamping Elements

## SHAFTLOCK 22 Clamping Element

Dimensions						Transmission Torque Force Mt Nm	Axial Ft kN	Contact Pressure Shaft P N/mm <sup>2</sup>	Locking Screws (DIN 912-12.9)		
Ød mm	ØD mm	L <sub>1</sub> mm	L <sub>2</sub> mm	L <sub>3</sub> mm	L mm				Qty.	Size	Tightening Torque Ts Nm
17	50	50	16.0	44	56	179	20	154	4	M6X45	17
18	50	50	16.0	44	56	190	20	146	4	M6X45	17
19	50	50	16.0	44	56	201	20	138	4	M6X45	17
20	50	50	16.0	44	56	211	20	131	4	M6X45	17
24	55	60	18.5	54	66	379	29	133	6	M6X55	17
25	55	60	18.5	54	66	395	29	128	6	M6X55	17
28	60	60	18.5	54	66	443	29	114	6	M6X55	17
30	60	60	18.5	54	66	474	29	107	6	M6X55	17
32	63	60	18.5	54	66	505	29	100	6	M6X55	17
35	75	75	22.0	67	83	684	36	91	4	M8X70	42
38	75	75	22.0	67	83	742	36	84	4	M8X70	42
40	75	75	22.0	67	83	782	36	80	4	M8X70	42
42	78	75	22.0	67	83	821	36	76	4	M8X70	42
45	85	85	24.5	76	93	1318	54	93	6	M8X80	42
48	90	85	24.5	76	93	1405	54	88	6	M8X80	42
50	90	85	24.5	76	93	1463	54	84	6	M8X80	42
55	94	85	24.5	76	93	2146	72	102	8	M8X80	42
60	100	85	24.5	76	93	2341	72	93	8	M8X80	42
65	105	85	24.5	76	93	2536	72	86	8	M8X80	42
70	115	100	29.0	90	110	4364	115	108	8	M10X95	84

